

# Research Library Renovation

Calculations for LEED Credit

Weber Analytics  
432 North Main Street, Suite 200  
Blacksburg, Virginia 24060

Operator Weber Analytics  
Telephone 540.553.6171  
Fax  
e-Mail [service@weberanalytics.com](mailto:service@weberanalytics.com)

---

## Table of contents

---

### **Research Library Renovation**

Project Cover	1
Table of contents	2
Luminaire parts list	3
<b>Research Library</b>	
Luminaires (layout plan)	4
3D Rendering	5
False Color Rendering	6
<b>Room Surfaces</b>	
<b>Workplane</b>	
Isolines (E)	7

Weber Analytics  
 432 North Main Street, Suite 200  
 Blacksburg, Virginia 24060

Operator Weber Analytics  
 Telephone 540.553.6171  
 Fax  
 e-Mail [service@weberanalytics.com](mailto:service@weberanalytics.com)

**Research Library Renovation / Luminaire parts list**

54 Pieces FORUM INC - PITTSBURGH, PA SAD-03-Cx4'-120-CC-MATTE-PBD 1/28W T5 LAMP 48x4.75x4.75"DIRECT LUMINAIRE WHITE REFL & 25-CELL .75"SPECULAR LOUVER w/WHITE OVERLAY UNIVERSAL BALLAST #B228PUNV-C WATTS=32  
 Article No.: SAD-03-Cx4'-120-CC-MATTE-PBD  
 Luminous flux (Luminaire): 1275 lm  
 Luminous flux (Lamps): 2900 lm  
 Luminaire Wattage: 32.0 W  
 Luminaire classification according to CIE: 100  
 CIE flux code: 57 90 99 100 44  
 Fitting: 1 x User defined (Correction Factor 1.250, T5 HO).

See our luminaire catalog for an image of the luminaire.

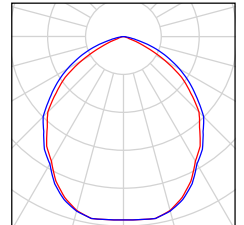

10 Pieces Generic Transl. Wht. Acrylic (4) 40W CFL TRANSLUCENT WHITE ACRYLIC ENCLOSURE  
 Article No.: (4) 40W CFL  
 Luminous flux (Luminaire): 6345 lm  
 Luminous flux (Lamps): 12600 lm  
 Luminaire Wattage: 165.0 W  
 Luminaire classification according to CIE: 50  
 CIE flux code: 18 41 69 50 50  
 Fitting: 4 x FOUR VBU 40 WATT T5 TWIN TUBE FLUORESCENT LAMPS RATED AT 3150 LUMENS EACH. (Correction Factor 0.100, (1) 26W CFL).

See our luminaire catalog for an image of the luminaire.

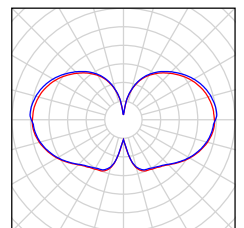

30 Pieces Whitegoods Lighting Ltd 100 Square Plasterin/Bezel Downlight 35W CDM-TC P/B100SDLID-CDMTC  
 Article No.: 100 Square Plasterin/Bezel Downlight 35W CDM-TC  
 Luminous flux (Luminaire): 1396 lm  
 Luminous flux (Lamps): 3300 lm  
 Luminaire Wattage: 40.0 W  
 Luminaire classification according to CIE: 100  
 CIE flux code: 69 89 97 100 43  
 Fitting: 1 x 35W/840 CDM-TC (Correction Factor 1.000).

See our luminaire catalog for an image of the luminaire.

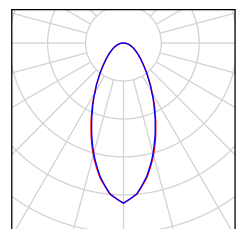

Weber Analytics  
 432 North Main Street, Suite 200  
 Blacksburg, Virginia 24060

Operator Weber Analytics  
 Telephone 540.553.6171  
 Fax  
 e-Mail service@weberanalytics.com

**Research Library / Luminaires (layout plan)**

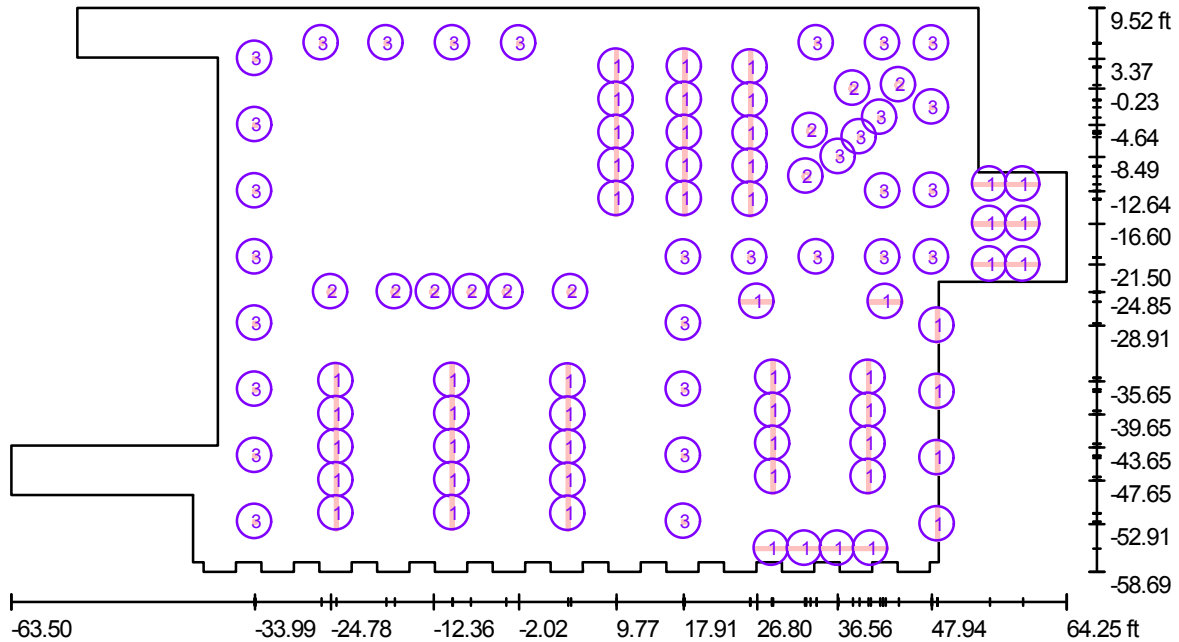

Scale 1 : 279

**Luminaire Parts List**

No.	Pieces	Designation
1	54	FORUM INC - PITTSBURGH, PA SAD-03-Cx4'-120-CC-MATTE-PBD 1/28W T5 LAMP 48x4.75x4.75"DIRECT LUMINAIRE WHITE REFL & 25-CELL .75"SPECULAR LOUVER w/WHITE OVERLAY UNIVERSAL BALLAST #B228PUNV-C WATTS=32
2	10	Generic Transl. Wht. Acrylic (4) 40W CFL TRANSLUCENT WHITE ACRYLIC ENCLOSURE
3	30	Whitegoods Lighting Ltd 100 Square Plasterin/Bezel Downlight 35W CDM-TC P/B100SDLID- CDMTC

Weber Analytics  
432 North Main Street, Suite 200  
Blacksburg, Virginia 24060

Operator Weber Analytics  
Telephone 540.553.6171  
Fax  
e-Mail [service@weberanalytics.com](mailto:service@weberanalytics.com)

## **Research Library / 3D Rendering**



Weber Analytics  
432 North Main Street, Suite 200  
Blacksburg, Virginia 24060

Operator Weber Analytics  
Telephone 540.553.6171  
Fax  
e-Mail service@weberanalytics.com

### Research Library / False Color Rendering

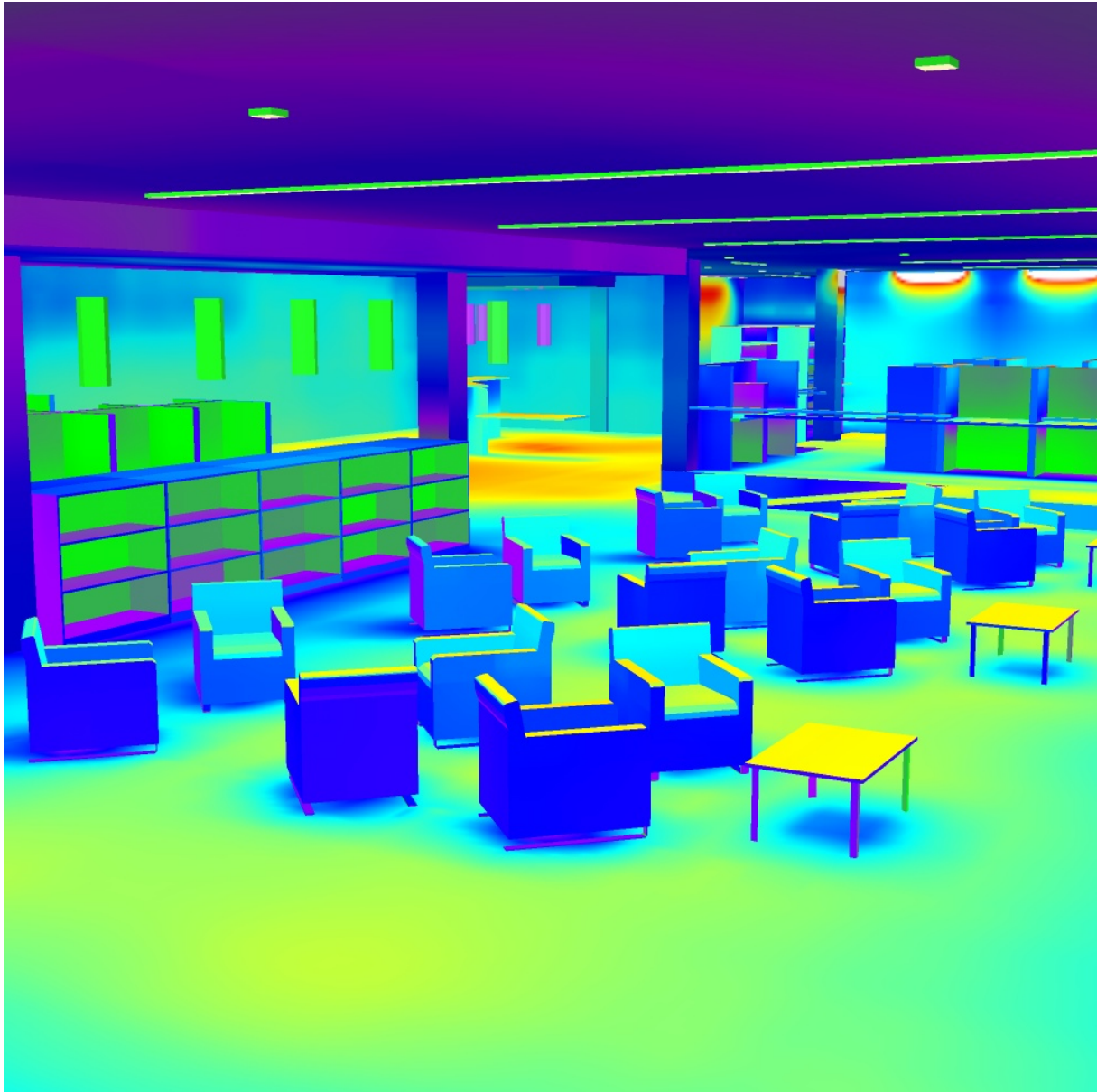

Weber Analytics  
 432 North Main Street, Suite 200  
 Blacksburg, Virginia 24060

Operator Weber Analytics  
 Telephone 540.553.6171  
 Fax  
 e-Mail service@weberanalytics.com

Research Library / Workplane / Isolines (E)

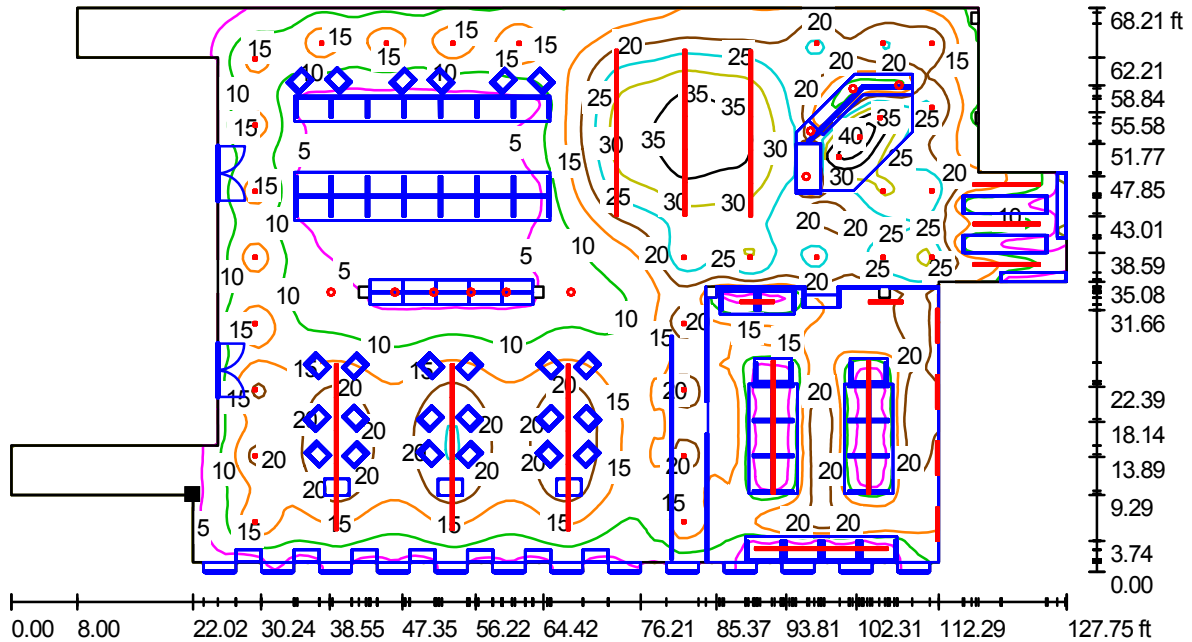

Values in Footcandles, Scale 1 : 279

Position of surface in room:  
 Marked point:  
 (-41.479 ft, -49.395 ft, 2.500 ft)

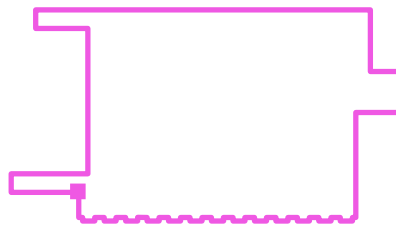

Grid: 128 x 128 Points

$E_{av}$ [fc]	$E_{min}$ [fc]	$E_{max}$ [fc]	u0	$E_{min} / E_{max}$
15	0.67	44	0.046	0.015